

наименование	модел АСК	PART №	пояснение	Цена в лв. с вкл. ДДС
<b>GM 5L40E</b>	1999-2005		BMW X5 3.0 D/ 330 D / RANGE ROVER 3.0 D	



К-т гарн. о-пръстени, сегменти

5L40E

156800X



Kit, Overhaul (w/o pistons) (all)

290.00



гарнитура картер

5L40E

31696225

Gasket, 5L40E Bottom Pan (Bonded) 2000-Up

40.00



гарнитура опашка

5L40E

31696226

Gasket, 5L40E Extension Housing (Bonded) (7 Holes) 2000-Up

28.00



Маслен филтър BMW 330

5L40E

156940



Filter w o/OUTLET SPACER TUBE shallow 99+ BMW 330

22.00



Маслен филтър BMW X5

5L40E

156944



Filter Oil BMW X5

25.00



к-т феродови дискове/ламели

5L40E

156750

Friction clutch set (EXCEPT AWD) 99+ BMW 330 D

540.00



к-т феродови дискове/ламели

5L40E

156750A

Friction clutch set (FSMD BMW X5 AWD ONLY ) 99+

540.00

феродови дискове/ламели

5L40E

156707-160

Friction forward clutch external teeth heg 1 side 99+

14.00

феродови дискове/ламели

5L40E

156706-160

FR5L40E forwd intl spl heg 1 side 99+

14.00



феродови дискове/ламели  
 феродови дискове/ламели  
 феродови дискове/ламели  
 феродови дискове/ламели  
 феродови дискове/ламели

5L40E  
 5L40E  
 5L40E  
 5L40E  
 5L40E

156700-160  
 156703-160  
 156702-160  
 156716-160  
 156701-160

Friction low/reverse,2nd cst internal spl heg 1 side 99+  
 Friction reverse clutch external spl heg 1 side 99+  
 Friction reverse clutch internal spl heg 1 side 99+  
 FR,2ND CL INTL SPL HEG 1 SIDE 99+  
 FR,2ND CST EXT SPL HEG 1 SIDE

14.00  
 14.00  
 14.00  
 14.00  
 14.00



Бутала първ. вграждане 9 бр.

5L40E

GEM.5L40E.MP



PISTON SET 9PCS O.E.M HUTCHINSON Molded

490.00



**Сол. закл. амбр. турбина О.Е.М** 5L40E

04 27 MV003 2540



**Solenoid lock-up**

220.00



**Ел. регулатор на налягане О.Е.М** 5L40E  
Семеринг опашка 5L40E  
Семеринг опашка 5L40E

04 27 MV003 1540  
70397  
70396



**Solenoid EPC /Electronic pressure control/**  
SEAL XT. HUOSING  
SEAL XT. HUOSING 2005- ON

220.00  
15.00  
17.00





семеринг помпа

5L40E

70395



Pump metal clad seal

18.00



К-кт конуси за монтаж на бутала

5L40E

A 00 99 EZ999 0011

165.00



Замразяващ спрей за мон. на бут. 5L40E

A 00 99 EZ000 0001 Seal-E-Zee Original (400ml) .....

60.00

**TH700/4L60E/4L65E**

1993-2006

CHEVROLET CORVETTE / HUMMER 1/2/3



К-т гарн. о-пръстени, сегменти

4L60E/TH700

KP33900FX

1997-2006 W/CORVETTE OUTPUT seal

160.00





Регулятор налягане

4L60E/TH700

MSOL-823

GM, 4L60E/4L65E pressure control 03+ EPC Corvette/Hummer

170.00



к-кт диск. амб. 3-4 едностр.

4L60E/TH700

057757A

PPk 700 series 3/4 clutch 1 sided hp 82+ high energy

170.00





Маслен филтър

4L60E/TH700

42242B

Filter, 4L60E/4L65E (Deep Pan, Truck & Van) 1997-03

22.00



Маслен филтър

4L60E/TH700

77710G AFT

Filter, (Corvette, Only) Inlet Tube 1997-Up

23.00



Маслен филтър

4L60E/TH700

77710Q AFT

Filter-Colorado/ Canyon (04-06)

23.00



Спирачен колан

4L60E/TH700

057961C

Brake band 2-4 CARBON WIDE 82+ HUMMER, Corvette

105.00



**AL4 - DP0**

1998 - 2006

Renault Megane, Scenic, Peugeot 306,307, 406,Citroen Xantia

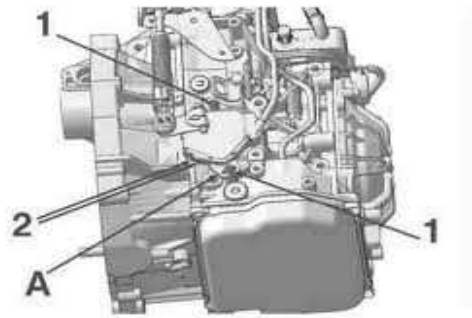

**Спирачен колан**

феродови дискове/ламели  
 феродови дискове/ламели  
 феродови дискове/ламели

<b>DPO/AL4</b>	155950
DPO/AL4	90310
DPO/AL4	90306
DPO/AL4	90308

**Brake band**

Friction E1 CI external teeth  
 Friction E1 CI internal teeth  
 Friction E2 CI external teeth

<b>96.00</b>
14.00
14.00
14.00



<b>феродови дискове/ламели</b>	<b>DPO/AL4</b>	<b>90309</b>
феродови дискове/ламели	DPO/AL4	90300
феродови дискове/ламели	DPO/AL4	90310
феродови дискове/ламели	DPO/AL4	90304
феродови дискове/ламели	DPO/AL4	90302

<b>Friction E2 CI internal teeth</b>	<b>14.00</b>
Friction F1 CI external teeth	14.00
Friction F1 CI external teeth Peugeot	14.00
Friction F1 CI external teeth Renault	14.00
Friction F1 CI internal teeth	14.00



**Маслен филтър** **DPO/AL4** **M29049**

**Oil filter - RENAULT , PEUGEOT, CITROEN** **26.00**



регулятор налягане OEM BW

DPO/AL4

0 27 MV003 0238

PEUGEOT / RENAULT / CITROEN EPC OEM Borg Warner

170.00

**MERCEDES 722.3**

1981-1997

MERCEDES 300 D / S 500





**К-т гарн. о-пръстени, сегменти**  
феродови дискове/ламели

**722.3**  
722.3

**064800**  
064700



**ОHK 722.3, 81-97 6 BOLT**  
FR MERCEDES 4 SPEED FRONT HEG 80+

**180.00**  
12.00



феродови дискове/ламели

**722.3**

**064702**



FR MERCEDES 4 SPEED REVERSE HEG 80+

**12.00**



феродови дискове/ламели к-кт	722.3	064752
феродови дискове/ламели	722.3	064704
Спирачен колан	722.3	31447
Спирачен колан	722.3	31446A

Friction clutch module 722.3,W4A040 81-97	120.00
FR MERCEDES 4 SPEED 4TH GEAR HEG 80+	12.00
Brake band, 722.3 Front (Semi Flex) 1981-97	130.00
Brake band, 722.3/722.5 Rear (Split) 1981-On	290.00



гарнитура картер	722.3	31409
------------------	-------	-------

PAN GASKET W5A030,W4A040,72(722.3;7225)	16.00
---	-------

**MERCEDES 722.4** 1983-1997

**MERCEDES 190 D / 230**





К-т гарн. о-пръстени, сегменти 722.4 071800



Overhaul kit 722.4, W4A020 83-97 6 BOLT

180.00

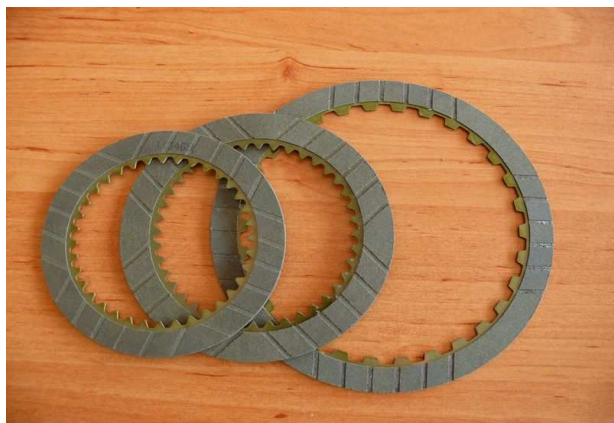

феродови дискове/ламели

722.4

071700

FR MERCEDES 190 1ST PACK HEG 84+

13.00



феродови дискове к-кт

722.4

071752

Frictions Modul MERCEDES 722.4,W4A020 83-97

120.00

феродови дискове/ламели

722.4

071702

FR MERCEDES 190 2ND PACK HEG 84+

13.00

феродови дискове/ламели

722.4

071704

FR MERCEDES 190 3RD PACK HEG 84+

13.00



гарнитура картер

722.4

31909

Pan gasket, 722.4 Bottom Pan 1984-97

14.00



Спирачен колан

722.4

31946A

Brake band, 722.4 Front (Semi Flex) 1984-97

120.00



Спирачен колан задна ск.

722.4

31947

Brake band, 722.4 Rear (Split) 1984-97

235.00



Маслен филтър

722.4

31440

Oil filter W4A040,W4A

15.00

**MERCEDES 722.6**

1996-2006

**MERCEDES E/C/S CLASS**



**К-т гарн. о-пръстени, сегменти 722.6 141800X**



**Overhaul kit 230.00**

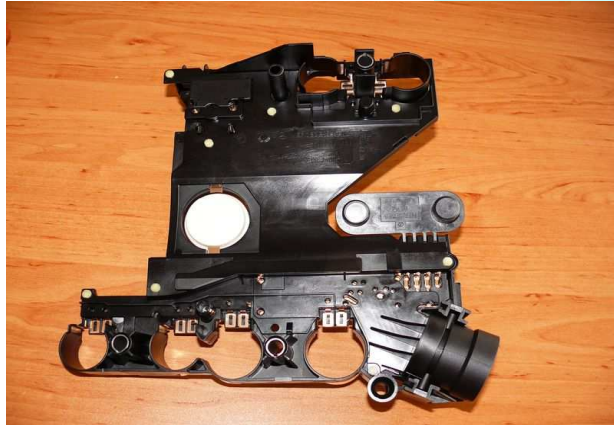

електронна платка (управлен.)

722.6

01 27 ES039 4008

electronique command plate OEM

390.00

феродови дискове/ламели

722.6

141702-160

Friction clutch 722.6 ,722.9 B2 EXT HEG 96+

14.00

феродови дискове/ламели

722.6

141706-160

FR MERC 722.6 K2 clutch heg 96+

15.00

феродови дискове/ламели

722.6

141706-214

Friction clutch 722.6 K-2 CL HEG SMALL ID 96+

15.00

феродови дискове/ламели

722.6

141706A214

Friction clutch 722.6 K-2 LARGE ID HEG 97+

14.00

феродови дискове/ламели

722.6

141708-216

Friction clutch 722.6 K3 CL HEG 98+

13.00



феродови дискове/ламели

722.6

141704-160

FR MERC 722.6 B3,722.9 br clutch heg 96+

14.00



феродови дискове/ламели	722.6	141700A206
феродови дискове/ламели	722.6	141700-210
феродови дискове/ламели	722.6	141701A206



K1 - B1 1 sided friction/internal spline W5A330	15.00
FR MERC 722.6 B1/K1 clutch heg 96+	14.00
K1 - B1 1 sided friction/external spline W5A330	15.00

**фер.диск.комп.едностр.04+39 бр. 722.6 141752C**

**Friction clutches module 1 sided 722.6, W5A330 04+ 39 pcs 370.00**



<b>фер. диск. комплект 2002-2004</b>	<b>722.6</b>	<b>141752B</b>
феродови дискове/ламели	722.6	141708-160
феродови дискове/ламели	722.6	141708A208
феродови дискове/ламели	722.6	141709A211

<b>Friction clutches module 722.6,W5A580 2002-2004</b>	<b>290.00</b>
FR MERC 722.6 K3 clutch heg 96+	13.00
K1 - 1 sided internal spline	15.00
K3 - 1 sided friction/external spline W5A330	15.00

СТОМАНЕНИ ДИСКОВЕ 722.6 141707-280  
 СТОМАНЕНИ ДИСКОВЕ 722.6 141707-180  
 СТОМАНЕНИ ДИСКОВЕ 722.6 141709-278

Steel plate 722.6 K2 CL Clutch 96+ 18.00  
 Steel plate 722.6 K2 Clutch 96+ 17.00  
 Steel plate 722.6 K3 Clutch 98+ 18.00



Маслен филтър 722.6 68712G AFT

Oil filter 96-0N 12.00



гарнитура картер 722.6 M31409C

Pan gasket W5A080, 96- OEM Germany 14.00



**MERCEDES 722.9**

2004-on

7 G-TRONIC ,CL500/CLK500/E500/S430/S500 05-06 .....



**К-т гарн. о-пръстени, сегменти**

**722.9**

**189800X**

феродови дискове/ламели

722.9

141708A208

феродови дискове/ламели

722.9

141709A211

феродови дискове/ламели

722.9

189710-185



**Overhaul kit**

**360.00**

Friction clutch 'K1 - 1 sided internal spline

16.00

Friction clutch 'K3 - 1 sided friction/external spline W5A330

16.00

Friction clutch K1 1 SIDE HEG INT SPL 04+

17.00



<b>феродови дискове/ламели</b>	<b>722.9</b>	189707-208
феродови дискове/ламели	722.9	189706-208
феродови дискове/ламели	722.9	189700-208
<b>феродови дискове/ламели</b>	<b>722.9</b>	189701-208
феродови дискове/ламели	722.9	189711-190
гарнитура картер	722.9	136500A GSK

<b>Friction clutch K2 1 SIDE HEG EXT SPL 04+</b>	<b>16.00</b>
Friction clutch K2 1 SIDE HEG INT SPL 04+	16.00
Friction clutch B1 1 SIDE HEG EXT SPL 04+	16.00
<b>Friction clutch B3 1 SIDE HEG EXT SPL 04+</b>	<b>16.00</b>
Friction clutch K1 1 SIDE HEG EXT SPL 04+	17.00
Pan gasket	18.00



гарнитура картер **722.9** M31408C

Pan gasket **18.00**

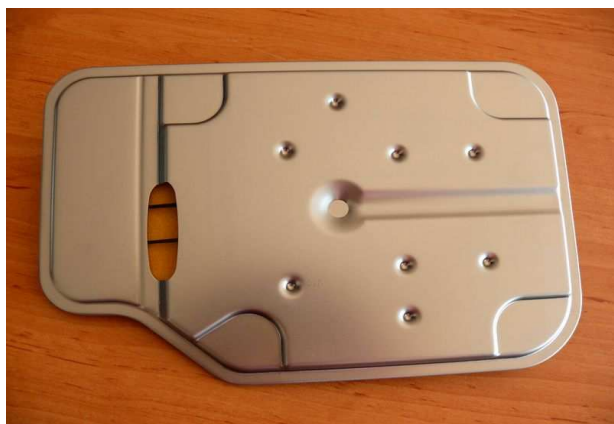

Маслен филтър

722.9

189940



Oil filter

40.00

**AISIN WARNER 55-50/51SN**

1999 - on

SAAB 9'3 9'5 02 up / VOLVO 40/60/70 series 01 up/OPEL

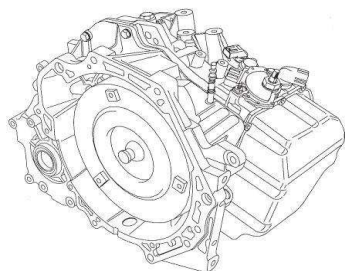



К-т гарн. о-пръстени, сегменти AW55/50SN 159800



Overhaul kit 55-51 99+

270.00

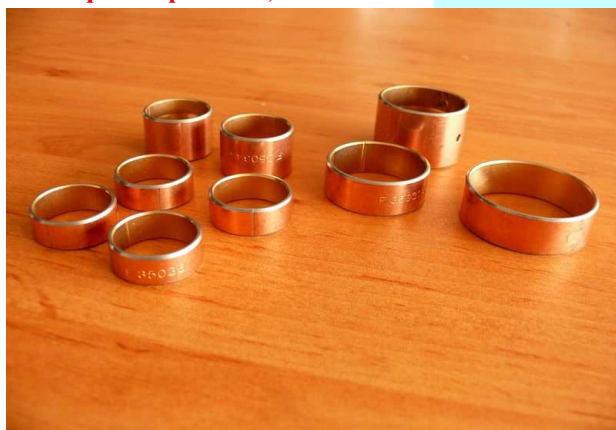

комплект втулки 55-50 SN 35030A

bushing kit car

148.00



**комплект втулки 55-51 SN**

феродови дискове/ламели  
феродови дискове/ламели

AW55/50SN  
AW55/50SN

**35030B**

79160  
79550

**bushing kit SUV**

Friction, Second Brake (B2) (exc Daewoo) (40T)  
Friction, Fifth Brake (B4) CI

**148.00**

16.00  
16.00



феродови дискове/ламели  
феродови дискове/ламели  
феродови дискове/ламели

AW55/50SN  
AW55/50SN  
AW55/50SN

159712-175  
159702-175  
110700B175



**Friction, Fifth Brake (B4) CI**

Friction, C1 Forward  
Friction, C2 Direct

**15.00**

15.00  
15.00



Маслен филтър

AW55/50SN

159940

Oil filter 55-50SN 99+ with rib

44.00



Спирачен колан

AW55/50SN

159950

Brake band AW 55-50 SN 99+

150.00



**AISIN WARNER TF60SN**

2003 - on

VW TIGUAN / MULTIVAN / GOLF / PASSAT / AUDI 2003-2008



**К-т гарн. о-пръстени, сегменти**  
 феродови дискове  
 феродови дискове  
 феродови дискове

<b>TF60SN</b>	<b>129800X</b>
TF60SN	129702-173
TF60SN	129700-170
TF60SN	129706-170

**Overhaul kit VW/AUDI AW ,09G,09K**  
 VW REV 03+(09G)  
 VW B1 (2ND&6TH) 03+(09G)  
 VW (4TH 5TH 6TH) 03+(09G)

**280.00**  
 18.00  
 18.00  
 18.00



феродови дискове  
феродови дискове  
феродови дискове

TF60SN  
TF60SN  
TF60SN

129704-168  
129708-173  
129706A152



Маслен филтър

TF60SN

M34340

VW (1ST 2ND 3RD 4TH) 03+(09G)  
VW (REV 3RD 5TH) 03+(09G)  
VW C2 4,5,6 CL60 SPL 03+(09G)

18.00  
18.00  
18.00



Filter,Oil VW ,Audi, Beetle,Golf, Passat, Jetta 09G-01

30.00





Маслен филтър

TF60SN

M34340A



Filter,Oil VW ,Audi, Beetle,Golf, Passat, Jetta 09G-02

30.00



Маслен филтър

TF60SN

M34341



Filter,Oil VW Transporter, Tiguan 09K 05-ON

30.00



гарнитура картер 8 дупки

TF60SN

M34308

Pan gasket 09G VW&Mini Cooper 8 holes

40.00

**AISIN WARNER TF80SC**

2005 - on

**VOLVO XC 90 / PEUGEOT / SAAB / OPEL**





К-т гарн. о-пръстени, сегменти

TF80SC

197800X



Overhaul kit W/O Piston

290.00



Маслен филтър

TF80SC

79575J

Filter oil

58.00



гарнитура картер

феродови дискове/ламели  
феродови дискове/ламели

TF80SC

TF80SC

TF80SC

79703X

AF40.FRP52

197706-170

Gasket,Pan TF-80SC

AF40-6 FRICTION C2 (4TH, 5TH,6TH)2005-

AF40-6 B2 REV

18.00

15.00

15.00



феродови дискове/ламели

феродови дискове/ламели

феродови дискове/ламели

TF80SC

TF80SC

TF80SC

197704-170

197702-170

197700-170

AF40-6 B2 REVERSE(3RD&5TH)

AF40-6 C2 (4TH 5TH 6TH)

AF40-6 C1 (1ST 2ND 3RD 4TH)

15.00

15.00

15.00



Спирачен колан

TF80SC

M35390

BAND TF80/81 SC, AF40 ,VOLVO,SAAB 05-ON

140.00

**AISIN WARNER TR 60SN**

2004 - on

PORSCHE CAYENNE / VW TOUAREG / AUDI Q7





**К-т гарн. о-пръстени, сегменти**

феродови дискове/ламели  
феродови дискове/ламели

**TR60SN**

TR60SN

TR60SN

**K79900J**

185706-200

185700-200



**Overhaul kit TR60SN**

FR AW TR-60SN 6 SPEED K-2 CL 04+

FR AW TR-60SN 6 SPEED B-1 CL 04+

**380.00**

17.00

17.00



феродови дискове/ламели  
феродови дискове/ламели

**TR60SN**

TR60SN

**185702-200**

185704-170



**FR AW TR-60SN 6 SPEED K-3 CL 04+**

FR AW TR-60SN 6 SPEED B-2 CL 04+

**17.00**

17.00



Маслен филтър

TR60SN

M34340C

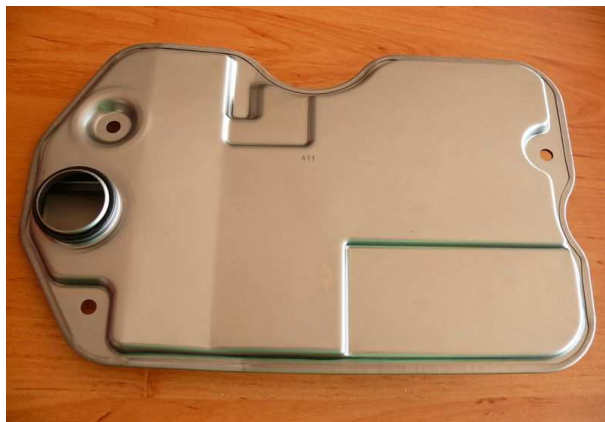

Oil filter

54.00



гарнитура картер

TR60SN

79706X

Pan gasket

48.00

**VW AG4/01M/01N**

1989-on

PASSAT / GOLF / SHARAN / JETTA



**К-т гарн. о-пръстени, сегменти**

гарнитура картер  
 гарнитура картер  
 гарнитура картер  
 гарнитура картер  
 гарнитура картер

**AG4/01M/01N 109806C**  
 AG4/01M/01N 34109A  
 AG4/01M/01N 34209C  
 AG4/01M/01N 34109P  
 AG4/01M/01N 34109B  
 AG4/01M/01N 34109

**Overhaul kit /01N**

095, 096, AD4 90-ON COVER MOLDED RUBBER  
 Pan gasket 098 EUROVAN 92-ON MOLDED RUBBER  
 PAN GASKET 095, 096,M AD4 90  
 PAN GASKET 095, 096,M AD4 90  
 PAN GASKE I 095, 096,M AD4 90

**180.00**

19.00  
 15.00  
 18.00  
 16.00  
 14.00



гарнитура картер след 1996

**AG4/01M/01N 109819A**

**GSK VW 01N OIL PAN RUBBER 96 on**

**18.00**





вулкан. бутала комплект

AG4/01M/01N

109670A

KIT Molded pistons VW 01M,01N,01P (7 pistons) 95 on

170.00



Бутала първ. вграждане 7 бр.  
вулкан. бутала комплект

AG4/01M/01N  
AG4/01M/01N

03 27 GK072 0094  
M34188

KIT Molded pistons / 7 pcs / VW 01M,01N,01P 95 on OEM  
VW 095 5pcs Molded Piston Kit RENAULT

255.00  
140.00



Маслен филтър след 1996 **AG4/01M/01N** 34140



Oil Filter, 096 (With Round Lip Seal Grommet) 1996-Up **17.00**



Маслен филтър до 1995 **AG4/01M/01N** 34040  
феродови дискове/ламели **AG4/01M/01N** 34122R



Oil filter AG-4 095, 096, 097, until 95 " **15.00**  
Friction, 095/096/ Low/Reverse Clutch (B1) .063" 5.75"OD **13.00**

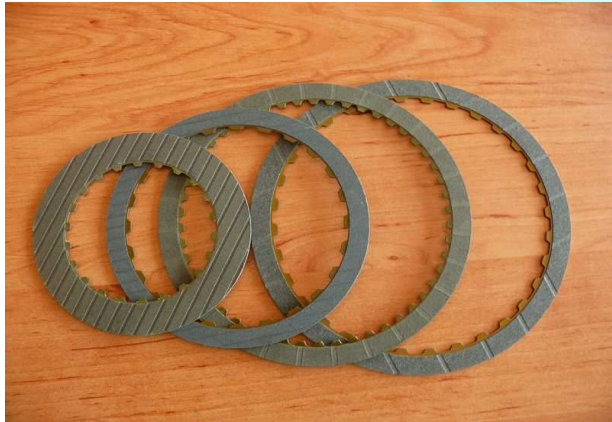

феродови дискове/ламели  
 феродови дискове/ламели  
 феродови дискове/ламели  
 феродови дискове/ламели

**AG4/01M/01N 109700**  
 AG4/01M/01N 109704A  
 AG4/01M/01N 109716  
 AG4/01M/01N 34126AR

**Friction AG4 K1,K2,HEG 90+ Forward clutch**  
 FR AG/AR4 B1 REVERS BREKE  
 FR K-3 3/4 CLUTCH High Energy 88+  
 Friction, 095/096/097/098 3-4 Clutch (K3) .063" 4.05"OD

13.00  
 13.00  
 13.00  
 13.00



стоманен притискателен диск  
 стоманени дискове

**AG4/01M/01N 109760A640**  
 AG4/01M/01N 109701-145

**Pressure plate VW AG4 K1 90+ 5.2 mm + 6.4 mm**  
 Steel clutches AG4 K-1 1ST&3RD

**45.00**  
 16.00

**ZF 4HP20**

1998-on

PEUGEOT 605-406 / MERCEDES VITO



**К-т гарн. о-пръстени, сегменти**

**ZF4HP20**

**1019.298.017**

**Overhaul kit PEUGEOT**

**270.00**



**К-т гарн. о-пръстени, сегменти**  
 феродови дискове/ламели  
 гарнитура картер  
 гарнитура междинна  
 гарнитура картер

ZF4HP20  
 ZF4HP20  
 ZF4HP20  
 ZF4HP20  
 ZF4HP20

**1019.298.010**  
 1019.273.019  
 1019.303.008  
 1019.322.056  
 83702X



**Overhaul kit MERCEDES VITO**  
 Friction clutch 4HP20;5HP19  
 Pan gasket  
 intermediate gasket MB VITO  
 Gasket, Oil Pan (rubber)

**270.00**  
 17.00  
 22.00  
 35.00  
 18.00



**Маслен филтър**

ZF4HP20

**1019.222.018**

**Oil filter Peugeot O.E.M.**

**37.00**





Маслен филтър	ZF4HP20	1019.222.019
Маслен филтър	ZF4HP20	113711 AFT
Маслен филтър VITO	ZF4HP20	113710 AFT

Oil filter Mercedes VITO O.E.M.

38.00

Oil filter Peugeot

24.00

Oil filter Mercedes Vito

24.00



маслена помпа к-кт	ZF4HP20	1019.210.025
--------------------	---------	--------------



oil pump

610.00

**ZF 5HP19FL/FLA**

1995-on

BMW 3(E46),5(E39),7(E38),Audi (A4, A8) '95-03, (A6) '97-03



К-т гарн. о-пръстени, сегменти

ZF5HP19FLA

1060.298.031

Overhaul kit FLA Audi

310.00

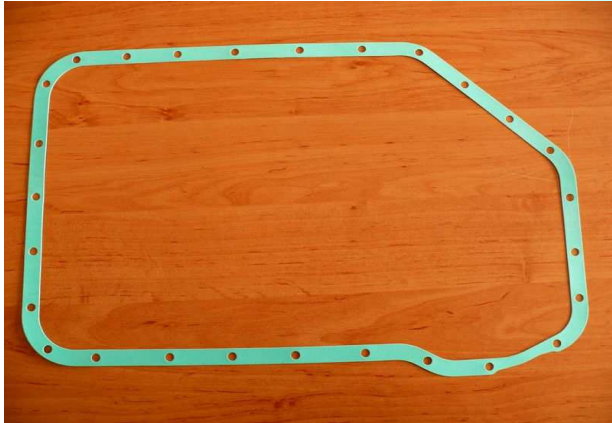

гарнитура картер

ZF5HP19FLA

1056.303.031

Pan gasket O.E.M.

28.00

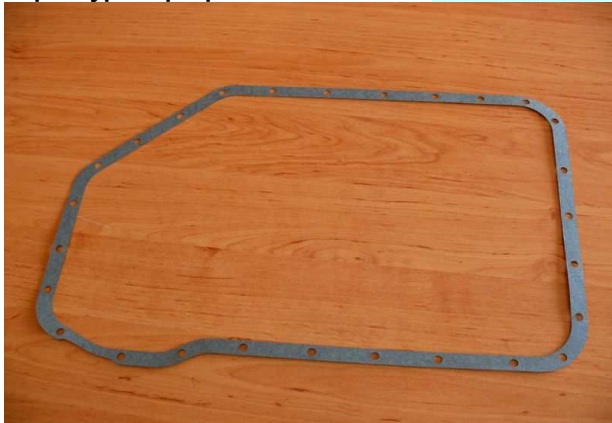

гарнитура картер

ZF5HP19FLA

32207B

Pan gasket

14.00





Оригин. масло за 5 степ. авт. ск.  
гарнитура картер  
гарнитура разд. кут.

ZF5HP19FLA  
ZF5HP19FLA  
ZF5HP19FLA

1060.390.002  
1056.337.013



Original automatic transmission fluid for 5 speed transmissions  
Pan gasket BMW  
gasket transfer case

27.00  
26.00  
12.00



Маслен филтър

ZF5HP19

0501.209.251

OIL FILTER All O.E.M.

55.00



**Маслен филтър**

Маслен филтър

феродови дискове/ламели  
 феродови дискове/ламели  
 феродови дискове/ламели  
 феродови дискове/ламели  
 феродови дискове/ламели

<b>ZF5HP19FLA</b>	<b>85710K AFT</b>
ZF5HP19FLA	247981
ZF5HP19FLA	1060.270.039
ZF5HP19FLA	104702-160
ZF5HP19FLA	1060.271.008
ZF5HP19FLA	1060.277.031
ZF5HP19FLA	103702-155

**OIL FILTER All**

OIL FILTER All

friction clutch  
 friction clutch A end D pack  
 friction clutch  
 Friction clutch  
 Friction clutch G Clutch (Center Support - Rear)

**16.00**

18.00

16.00

14.00

15.00

15.00

14.00

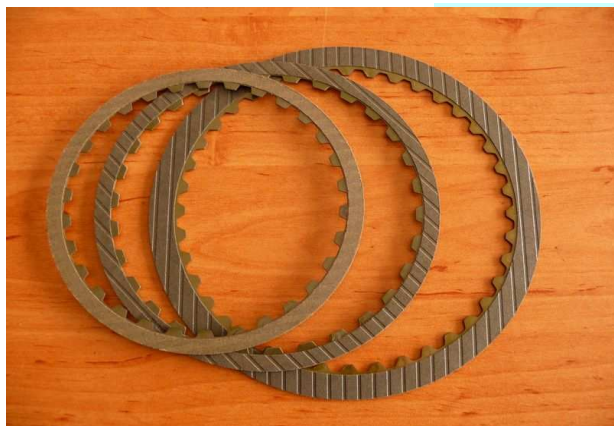

феродови дискове/ламели  
 феродови дискове/ламели  
 стоманени дискове  
 плоча помпа  
 плоча помпа

ZF5HP19FLA  
 ZF5HP19FLA  
 ZF5HP19 FLA  
 ZF5HP19  
 ZF5HP19

1060.272.003  
 104700  
 1060.377.002  
 1060.310.091  
 1056.310.123

Friction clutch  
 Friction clutch E pack  
 Steel plates  
 pump plate  
 pump plate

15.00  
 14.00  
 16.00  
 60.00  
 60.00



картер маслен

ZF5HP19

1060.203.006

oil sump

190.00



барабан D+G

ZF5HP19

1060.373.014

drum clutch D+G

210.00



маслена помпа  
маслена помпа

ZF5HP19  
ZF5HP19

1060.210.024  
1060.210.047



oil pump Audi  
oil pump BMW

270.00  
310.00

**ZF 5HP24/24A**

1995-on

**BMW /Jaguar 96-03 /Range Rover 99-03/Audi A8 1997-03/A6**



**К-т гарн. о-пръстени, сегменти**  
 феродови дискове/ламели  
 феродови дискове/ламели

**ZF5HP24A**  
 5HP24  
 ZF5HP24

**1058.298.023**  
 1058.270.003  
 1058.270.025



**Overhaul kit Audi quattro**  
 friction clutch  
 friction clutch

**270.00**  
 16.00  
 16.00



феродови дискове/ламели  
 феродови дискове/ламели  
 феродови дискове/ламели  
 стоманени дискове  
 стоманени дискове  
 стоманени дискове  
 гарнитура картер  
 гарнитура картер  
 гарнитура картер

ZF5HP24 1058.270.029  
 ZF5HP24 1058.270.028  
 ZF5HP24 053706  
 ZF5HP24 113701-180  
 ZF5HP24 132703-210  
 ZF5HP24 132701  
 ZF5HP24 32207A  
 ZF5HP24 1058.303.015  
 ZF5HP24 0501.314.899

friction clutch

friction clutch

friction plate clutch A, C

Steel plates ZF5HP24 F PACK/5HP30 E1,F PACK91

Steel plates ZF5HP24 B,D,E PACK SEL 97+

Steel plates A, C pack 97+

Pan gasket 97-ON JAGUAR XK8, BMW 840CI FIBER

Pan gasket Audi

Pan gasket BMW

15.00  
 16.00  
 13.00  
 14.00  
 15.00  
 15.00  
 18.00  
 28.00  
 28.00



Маслен филтър

ZF5HP24

0501.006.460

Oil filter Audi with tube 22mm O.E.M.

52.00



Маслен филтър

бутало амбреаж F  
диафрагма амбр. F

ZF5HP24

ZF5HP24

ZF5HP24

32242

0501.212.967

0501.313.573

Oil filter BMW

piston cluch "F"  
cup spring clutch F

31.00

98.00

10.00



първичен вал /входящ/  
барабан F

ZF5HP24  
ZF5HP24A

1058.270.040  
1058.277.001

input shaft  
drum clutch F

540.00  
280.00

**ZF 6HP19**

2004-on

**BMW / JAGUAR**



К-т гарн. о-пръстени, сегменти

ZF6HP19

1071.298.002

Overhaul kit BMW/JAGUAR

340.00





филтър-картер BMW  
феродови дискове/ламели

ZF6HP19  
ZF6HP19

0501.216.244  
1071.271.033

oil filter and pan BMW X3  
friction clutch

220.00  
17.00

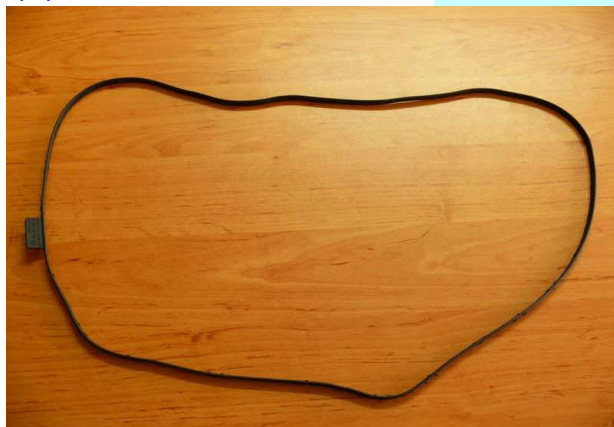

гарнитура картер гумена  
стоманени дискове  
стоманени дискове

ZF6HP19  
ZF6HP19  
ZF6HP19

0501.323.156  
1071.371.052  
1071.371.093

Pan gasket molded BMW  
Steel plates  
Steel plates

32.00  
18.00  
22.00

**ZF 6HP19 A**

2004-on

AUDI / VW



Оригин. масло за 6 степ. ск. кут. ZF6HP19FLA



Original automatic transmission fluid for 6 speed transmissions

38.00



Оригин. масло за 8 степ. авт. ск. кутия



Original automatic transmission fluid for 8 speed transmissions

58.00



**К-т гарн. о-пръстени, сегменти** ZF6HP19FLA 1071.298.010



**Overhaul kit AUDI**

**340.00**



**Управление МЕХАТРОНИК** ZF6HP19FLA

**МЕХАТРОНИК**

**2300.00**



Маслен филтър

ZF6HP19AV

0501.212.401

Oil filter AUDI / VW

68.00

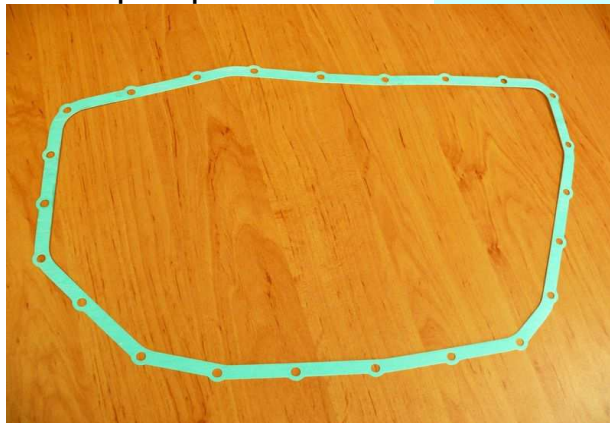

гарнитура картер AUDI

ZF6HP19A

1071.303.006

Pan gasket AUDI/VW

32.00

феродови дискове/ламели

ZF6HP19FLA

1071.272.004

friction clutch

15.00



**феродови дискове к-кт**  
 стоманени дискове  
 стоманени диск- диафрагмен

**ZF6HP19FLA**  
**ZF6HP19FLA**  
**ZF6HP19FLA**

**1071.298.013**  
 1071.372.025  
 0501.320.600

**friction clutch set**  
 Steel plates  
 Steel plates diaphragm

**230.00**  
 14.00  
 14.00



**първичен вал /входящ/**

**ZF6HP19FLA**

**1071.271.109**



**input shaft**

**560.00**

**ZF 6HP26**

**2002-on**

**AUDI / BMW / JAGUAR**



**К-т гарн. о-пръстени, сегменти**

**ZF6HP26**

**1068.298.052**

**К-т гарн. о-пръстени, сегменти**

ZF6HP26

**1068.298.051**

феродови дискове/ламели

ZF6HP 26

1068.271.018

феродови дискове/ламели

ZF6HP 26

1068.277.002

феродови дискове/ламели

ZF6HP 26

1068.277.004

феродови дискове/ламели

ZF6HP 26

183702-160

феродови дискове/ламели

ZF6HP 26

183700-220

феродови дискове/ламели

ZF6HP 26

183700-160

**Overhaul kit AUDI quattro**

**380.00**

**Overhaul kit BMW/JAGUAR**

260.00

friction clutch

17.00

friction clutch

19.00

friction clutch

19.00

Friction clutch 4TH,5TH,6TH

14.00

Friction clutch 3RD 5TH,REV,(B),2ND-6TH BRK

14.00

Friction clutch INPUT,FORWARD(A),L&R

14.00



феродови дискове-ламели к-кт ZF6HP 26

1068.298.036

friction clutch set

255.00



Управление МЕХАТРОНИК  
стоманени дискове

ZF6HP26

1068.371.047



MECHATRONIC  
Steel plates

2300.00  
15.00



филтър-картер BMW

ZF6HP26

0501.216.243



oil filter and pan BMW / OEM

180.00



филтър-картер BMW

ZF6HP26

183940



oil filter and pan BMW / aftermarket

140.00





филтър-картер JAGUAR

ZF6HP26

0501.216.244

oil filter and pan JAGUAR

220.00



Маслен филтър

ZF6HP26

0501.212.974

Oil filter AUDI W12

67.00



Маслен филтър

ZF6HP26

0501.213.359

Oil filter BMW / MASERATI

57.00



гарнитура картер алумин-гума

ZF6HP26

0501.322.155

pan gasket /metal-bonded/ AUDI (6HP28AF)

62.00

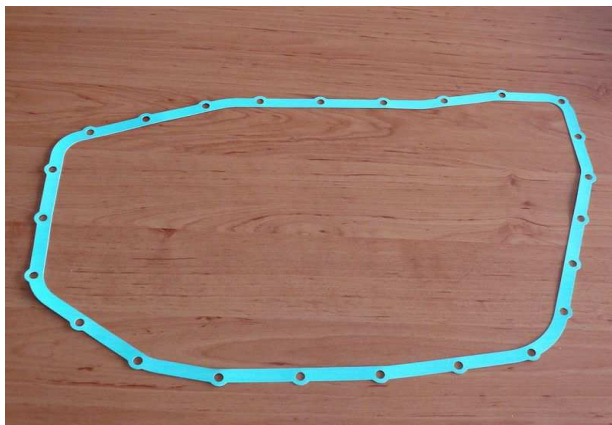

гарнитура картер

ZF6HP26

1068.303.012

pan gasket AUDI W12

28.00

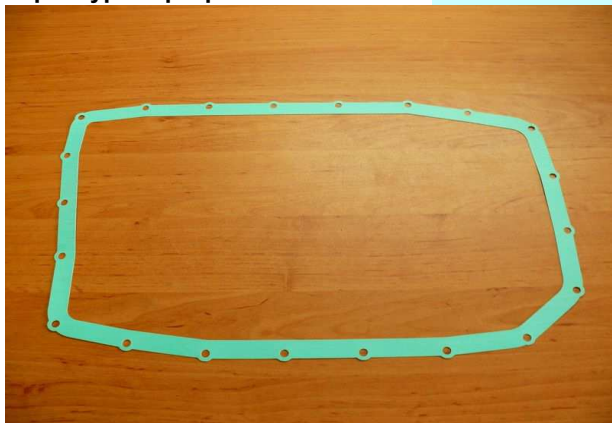

гарнитура картер

ZF6HP26

1068.303.017

pan gasket BMW / FORD (USA) / JAGUAR

27.00





първичен/входящ вал

ZF6HP26

1068.271.102

input shaft

510.00

**ZF 6HP32**

2001-ON

BENTLEY / PHAETON / AUDI / BMW





**К-т гарн. о-пръстени, сегменти**

**ZF6HP32**

**1070.298.002**



**Overhaul kit BMW/BENTLEY**

**420.00**

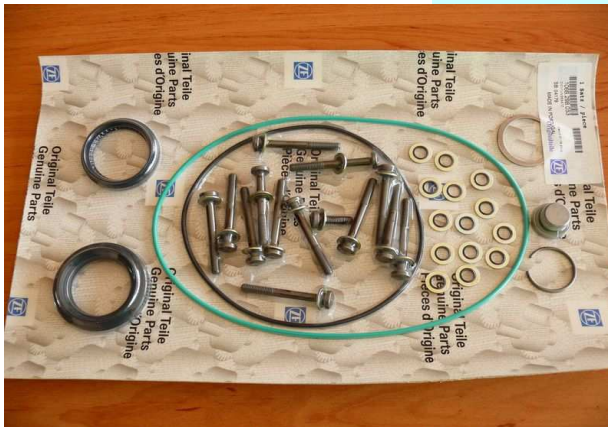

**Уплътнител. к-т диференциал**

**ZF6HP32**

**1068.298.053**

феродови дискове/ламели

ZF6HP32

1070.277.011

феродови дискове/ламели

ZF6HP32

1070.271.008

феродови дискове/ламели

ZF6HP32

1070.277.004

феродови дискове/ламели

ZF6HP32

1070.271.008



**Overhaul kit Front-axle diff. Audi**

**280.00**

friction clutch

18.00

friction clutch

19.00

friction clutch

18.00

friction clutch

19.00



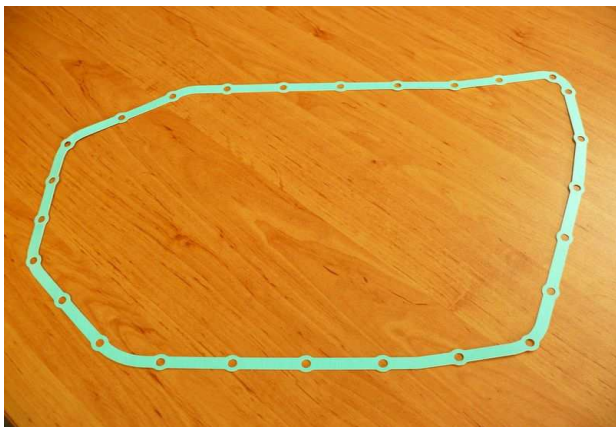

гарнитура картер  
гарнитура разд. кут.

ZF6HP32  
ZF6HP32

1070.303.009  
0501.322.728

**Pan gasket BMW**  
gasket transfer case (Audi;Phaeton)

**45.00**  
213.00



гарнитура картер

ZF6HP32

0501.326.068

**Pan gasket Audi W12 Metal**

**65.00**



Маслен филтър

ZF6HP32

0501.215.992

Oil filter Audi W12

60.00









































































































































































































































































































































































































































































































































































































































































